



PPU-S
(People Picker Upper – Standing)

USER MANUAL

INDEELIFT, INC.
5143 Tesla Road Livermore, CA 94550
USA 844-700-5438
www.IndeeLift.com

INDEELIFT, S.L.
Barcelona, SPAIN
international@indeelift.com
www.IndeeLift.com

PPU-S User’s Manual

NOTICE

Please read this entire manual *before* using the product and retain for future reference.

TABLE OF CONTENTS

Safety Symbols:..... 3

Introduction: 3

PPU-S Features/Functionality: 4

PPU-S Component Identification: 5

 Wired Remote..... 6

 Rise-Assist Handles..... 7

Preparing the PPU-S for Use..... 9

 Unpacking the PPU-S: 9

Charging the Battery:..... 11

General PPU-S Operation:..... 12

Standing Function 15

Securement Belt Information: 16

Maintenance: 17

Troubleshooting / Service: 18

Warranty Information: 19

Physical Specifications: 18

Electrical Specifications:..... 18

Owner’s Notes: 19

IndeeLift – the first human floor lift designed and engineered to alleviate the grief, hazards and hassles of recovering from a fall!

PPU-S User's Manual

THIS PRODUCT MAY CONTAIN THE POSSIBILITY FOR CERTAIN HAZARDS IF NOT USED IN THE CORRECT MANNER. EVERY OPERATOR IS RESPONSIBLE FOR READING AND UNDERSTANDING ALL OF THE OPERATIONAL AND SAFETY PRECAUTIONS AVAILABLE FOR THIS PRODUCT.

Safety Symbols:



Will result in Death or Serious Injury



Could result in Death or Serious Injury



Could result in Minor or Serious Injury



Not related to Personal Injury

Introduction:

The patented IndeeLift family of products are designed to assist individuals who have mobility challenges and are unable to get up from the floor or a seated position without assistance. IndeeLift's "People Picker Upper" (PPU) models are a class of patient lifts unlike any other available. The rugged and reliable IndeeLift PPU's are purpose-built appliances designed in the USA with UL and CE certified components for use in the home and care environments. IndeeLift's professional line offers models for professional-healthcare and emergency-medical-services.

The PPU-S is a floor-to-stand (FTS) lift designed for self or assisted operation in the home or care environments. This appliance can lift a person up to 300 pounds (136 kg). **This unit is referred to as the "PPU-S" throughout this manual.**

The PPU-S can be used to lift a person from the floor, wheelchair, commode, couch, or any other place a user may be located and needs assistance to get to a seated or standing position. PPU-S lifts are also configured to raise the user from a standing position at floor level to assist in getting onto a bed, or to gain access to higher locations in the home without having to climb a stepladder, along with other places that a mobility challenged user may need to access. The PPU-S has been designed with care providers in mind.

As a fall recovery appliance, the PPU-S is extremely maneuverable, and its small footprint allows fall recovery to occur in even the tightest of places. IndeeLift's line of products replace large and cumbersome sling-style lifts, helping fallen people to recover and get back on their feet quickly, while greatly reducing the risks.

⚠ WARNING Individuals that fall must be assessed for injuries that may require medical assistance. Use of this human floor lift after sustaining a serious injury resulting from a fall is discouraged to avoid what could result in Death or Serious Injury. Instead of using this lift if a serious injury is noted, phone Emergency Services (911,112) for medical assistance.

PPU-S User's Manual



This product contains moving parts where hands or feet could be injured if they are in an inappropriate location. Users and caregivers must be aware of everyone's body parts that could be trapped between the seat platform and the floor or between the seat platform and any obstruction located above the seat platform level, that when contacted, could cause Minor or Serious Injury.



PPU-S Features/Functionality:

Seated Lift

The IndeeLift PPU-S is primarily designed to raise a seated person from the floor, or any level above the floor, to a height that allows the user to stand directly up or to be transferred as required.

For users with less mobility, the transfer directly to a wheelchair or power chair is accomplished by raising the seat height to about 21" (53 cm), which allows a height difference of 1-2 inches (2.5-5cm) for lift-free transfers from most seated positions or whatever height that will allow a gravity-assisted transfer.

Once up from the floor, the fallen person can stop at chair height to take a breath and/or rest comfortably or simply get up and walk away or be directly transferred to a wheelchair, bed, toilet or recliner, all without the risk of injuries related to the fall recovery. The user can also be lifted to a full standing height allowing them to walk away without manually standing from a chair height.

Use as a Standing Lift

A secondary function of the PPU-S is to provide lift assistance to a standing person needing a little lift to access a bed or some tall cabinets or the shelf in the closet at home or the office.

The PPU-S provides users with a method to be lifted while standing to a safe level 12-14 inches from the floor. This application can assist the user onto a bed that may be the perfect height to get up from but too tall for the user get up onto. This function can also assist where single or dual step level changes may need to be overcome in the home or office.

Small Footprint and Easy Portability

The PPU-S is a portable lift that is rolled around on wheels like a traditional dolly. The small footprint allows it to be positioned in many places other lifts simply cannot go. With a turning radius of 34" (86 cm), the PPU-S can go just about anywhere including most small bathrooms and hallways.

Optional Mounting Ramp Seat-Tilt

The PPU-S patented design includes a mounting ramp seat that eliminates the need to ever "lift" a person manually and a tracking function that allows the seat to shift forward as the user is lifted and shifting their weight onto their legs. A user on the floor either scoots onto the lift using the front ramp or they can tilt up onto the seat. The PPU-S seat plate can either be locked in a stationary position or unlocked to allow the seat plate to rotate forward to allow a user to get to a standing position. Two locking tabs are located at the rear of the seat plate, one on each side of the main vertical column.

Wired Remote

The wired remote has a 5' (1.5m) retractable cord, allowing the user or a helper to operate the lift. The wired remote has physical, easy-operate button controls that indicate the up and down functionality. The wired remote is stored on the PPU-S's handles with the hanger clip.

Adjustable and/or Removable Rise-Assist Handles

The rise-assist handles have been engineered to provide leverage for the seated party to assist in the process of standing once they are up from the floor. The arms can swing away from the seat as needed. They are also

PPU-S User's Manual

removable to allow for mount assistance or a direct transfer to a wheelchair or other destination.

Rechargeable Battery

The PPU-S comes standard with a rechargeable Lithium-Ion battery pack and charging unit. Charging is accomplished by plugging the charging unit's AC power cord into a standard AC wall power outlet, (see **Preparing the PPU-S for use** on Page 8). A full charge takes about eight hours. The control system will provide a beep tone when operated and batteries are in need of being charged.

WARNING California requires the following notice: **WARNING: Lithium-ion batteries and products that contain lithium-ion batteries can expose you to chemicals including cobalt lithium nickel oxide, and nickel, which are known to the State of California to cause cancer and birth defects or other reproductive harm.**

NOTICE Lithium-Ion batteries offer light weight, high energy density, low memory effect and long-life. The charger automatically shuts off when charging is complete, which prevents over-charging. The battery should be charged in a clean, dry location, away from direct sunlight, sparks or flame. Failure to recharge the battery at least once every three months *may* result in the battery no longer accepting a charge. The battery should be fully charged before storing the PPU-S for extended periods. If the battery needs replacing, dispose of the old battery at a recycling center that accepts rechargeable batteries.

PPU-S Component Identification:

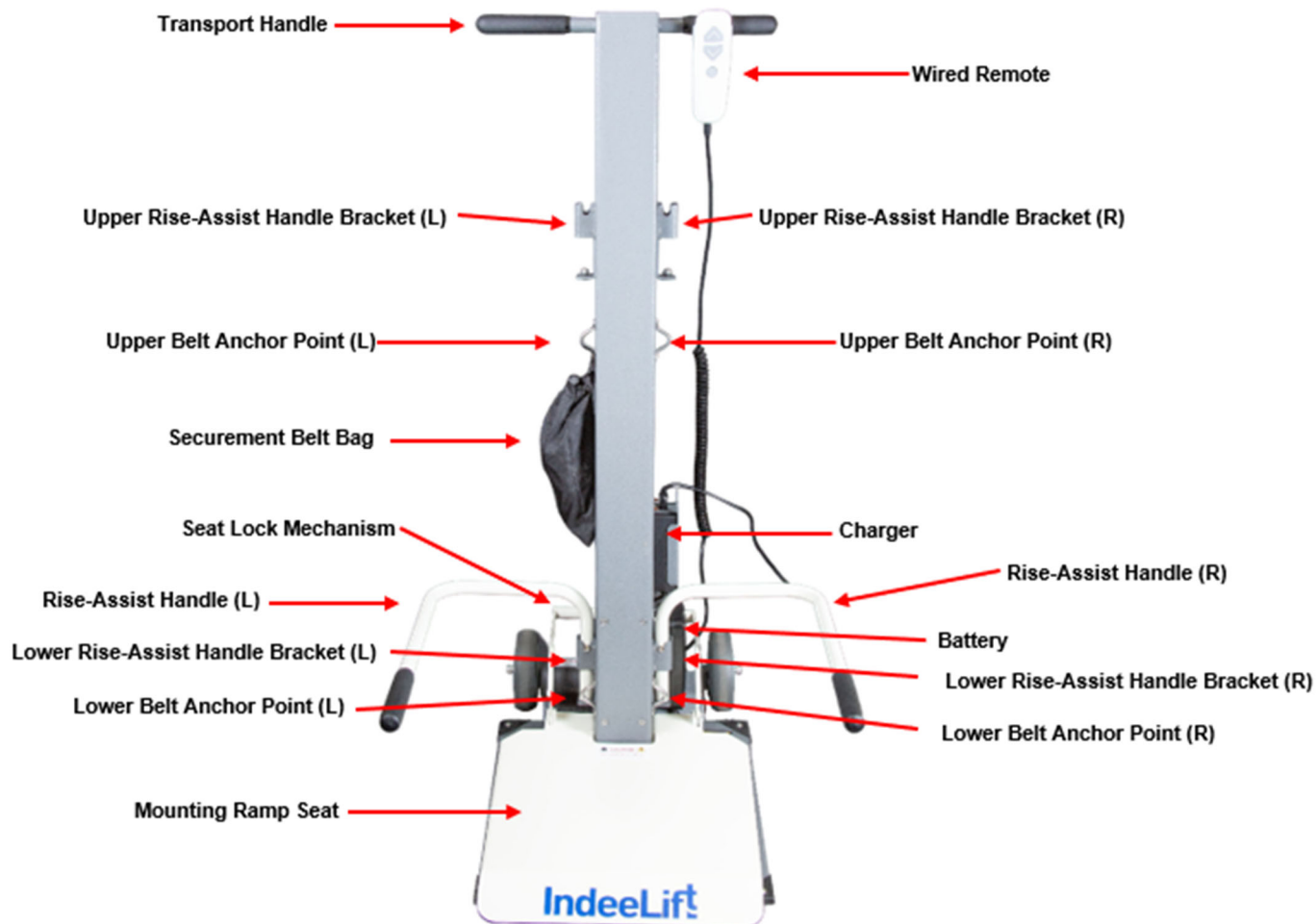

PPU-S User's Manual

Components and Controls:

Wired Remote

WARNING Power cords could cause strangulation. Keep young children from playing with or around the PPU-S to avoid mishaps that could result in death or serious injury.

The wired remote control is connected to the PPU-S with a coiled cord and is used to raise and lower the seat by pressing the up or down button. Raising or lowering the seat takes approximately 75 seconds. The wired remote has graphics indicating the up and down functionality. The wired remote is generally stored on the PPU-S's handles with the hanger clip. *If intended for self-operation, the wired remote should be stored on one of the rise-assist handles with the seat lowered to the ground.*



NOTICE If the unit is intended for self-operation, use the hanger clip on the back of the wired remote to place it on one of the lower rise-assist handles (Fig 1). If the unit is intended for assisted operation, place the wired remote on one of the upper transport handles (Fig 2).



Fig 1



Fig 2

PPU-S User's Manual

Rise-Assist Handles

The rise-assist handles provide support and balance when standing from the seat or when using the PPU-S in a standing mode. The rise-assist handles are positioned on the lower bracket for seated operation and on the upper brackets for standing operation. If desired, one or both rise-assist handles can be swung away from the seat by lifting one inch and then rotating them away from the seat. They are also removable to allow a direct transfer to a wheelchair or other destination. To remove a rise-assist handle, lift the handle upward.



Rise-Assist Handles Shown in Lower and Upper Brackets

To insert a rise-assist handle, push the lower end through the receiver bracket until the lower end bottoms out on the domed base (Fig 2), then push firmly until it is seated and the lock-pin located on the rise-assist handle is resting securely in the bracket.



Fig 1



Fig 2

PPU-S User's Manual

Mounting-Ramp Seat

The PPU-S mounting-ramp seat (seat mount) includes two modes of operation, locked and unlocked. Locked mode renders the seat mount rigid and is used when a person is being lifted from the floor or being transferred to or from another seated position (i.e., wheelchair, commode, bed, etc.). The optional unlocked mode is used when raising a person from a seated position to fully standing. The seat mount is unlocked in preparation to raise the user to standing. Unlocked mode allows the seat mount to rotate forward as the user is raised, shifting their weight onto their legs.

A spring under the seat mount keeps the locking mechanism in a locked position. When the Lock Release Levers are released by pulling them towards the seat mount, the seat mount mechanism is unlocked, and when the rear end of the seat mount is pushed downward, the locking system will automatically lock.

Two Lock Release Levers are located at the rear of the seat mount, one on each side of the main vertical column (Fig 1). The Lock Release Levers are to be used simultaneously and pulled forward to release the seat for tilting. For users who are not able to operate the Lock Release Levers with two hands, there is a Lock Release Bar assembly that can be attached to the locking tabs (Fig 3) that allows the seat mount to be unlocked using only one hand.

How to lock and unlock the seat mount:

1. Mount Lock Release Levers: The default configuration has two lock release levers, one on the left side and one on the right side. Both left and right Lock Release Levers must be pushed forward simultaneously to unlock both sides so that the seat mount can be released and tilt forward upon rising. (Fig 1 & 2)
2. Lock Release Bar: This allows the left and right Locking Levers to function simultaneously. The user pushes either side of the Lock Release Levers or the Lock Release Bar up and forward to unlock the seat panel. (Fig 3)
3. To re-lock the seat mount platform: Push the rear of the seat mount platform downward.

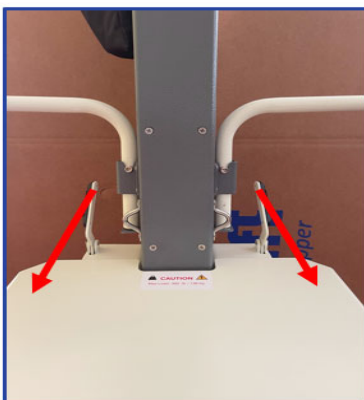

Fig 1



Fig 2



Fig 3

NOTE: The default seat-lock configuration requires both seat lock levers to be pushed forward simultaneously to release the seat. This eliminates any possible inadvertent release of the seat tilt function. Some users may have mobility challenges that will not allow them to reach rearward and push both levers forward simultaneously. The PPU-S comes with a Lock Release Bar assembly that can be attached to allow a single hand to lift the Lock Release Bar to disengage the seat lock.

CAUTION

The Seat Locks **MUST** be engaged to raise a person from the floor or for transfers on to or off of the PPU-S seat platform!

PPU-S User's Manual

Preparing the PPU-S for Use

Unpacking the PPU-S:

The PPU-S comes packaged for shipment in an L-shaped carton that is sealed with shipping tape. *The unit ships without the wheels attached.* Packed inside the shipping carton will be the PPU-S, a corrugated box that holds the wheels, the rise-assist handles, the seat lock release bar mechanism, and the user manual which is packaged with both the AC power cord that connects to the battery charger and the wheel components.

- Cut or remove the shipping tape on the top edges of the carton and remove the top layer.
- Open the top flaps to expose the corrugated box that contains the components shown above.
- Remove the corrugated box and the top layer of the box covering the seat mount.
- Stand the packing carton upright with the heavy L-shaped end down.
- Unfasten the transport handles from the box.
- Slide the PPU-S out of the box in its upright position on the floor.
- Remove the securement belt bag and the remote control from the box and attach them to the PPU-S.
- Attach the wheels by following the illustration below using the wheel components and wrench.
- Test the PPU-S by raising and lowering the seat using the wired remote's up and down buttons.
- Properly dispose of the packaging materials.



Wheel Mounting Illustration:

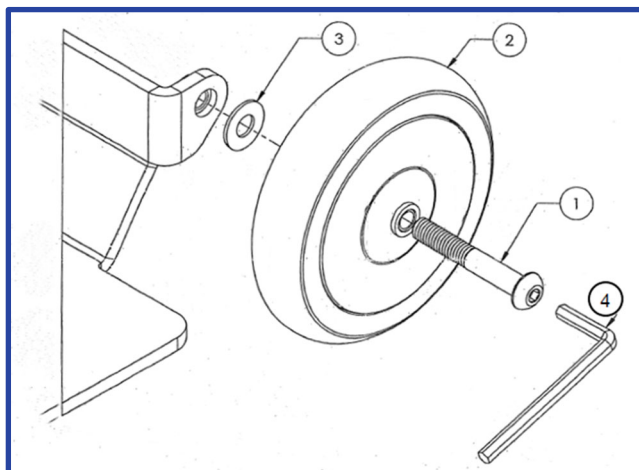

Wheel Parts List:

Item No.	Description	Quantity
1	Screw 3/8-16x2.5	2
2	Caster Wheel	2
3	Washer, Flat, 3/8"	2
4	HEX Key Wrench	1

PPU-S User's Manual

Seat Lock Release Bar Assembly Instructions

The Lock Release Bar assembly includes: 1 crossbar, 2 lever extensions, 4 round head screws and 2 flathead screws (Fig A).

To Install the Lock Release Bar: Using a Phillips screwdriver, unscrew the black plastic fittings that are on the outside of each Release Lever (Fig B) and discard. Fit the appropriate lever extension onto the outside of each of the Release Levers and attach with two round head screws on each side. The crossbar is then attached to the left and right lever extensions and secured with a single flathead screw per side. Once fully assembled, tighten each screw to ensure they are secure (Fig C). See illustration of Seat Lock Release Bar below.



Fig A



Fig B



Fig C

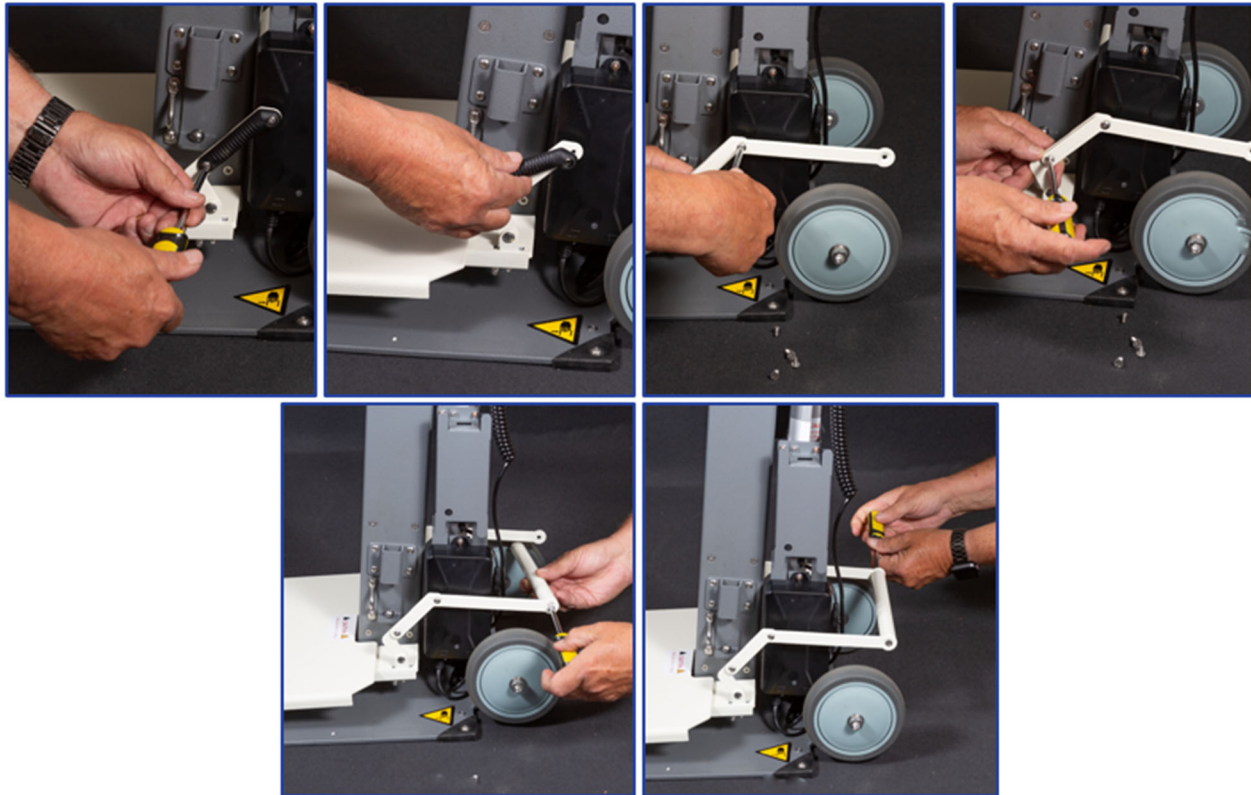

Installation of Seat Lock Release Bar

PPU-S User's Manual

Charging the Battery:

NOTICE

It is recommended that the PPU-S be fully charged *before* its first use.

Position the PPU-S near a standard commercial AC wall power outlet.

Attach the female end of the AC power cord to the connector on top of the PPU-S's battery charger. Fig 2

Attach the male end of the AC power cord to a standard commercial AC wall power outlet. Fig 3

The LED light on the battery charger will illuminate green within 15 seconds. Fig 2

The LED light on the battery will illuminate red when the battery is low and will change to green upon reaching a full charge. Fig 4 and 5

After an initial charge of up to eight hours, the battery is fully charged and the red LED on the battery turns green. Fig 4 and 5

Once the unit is fully charged, disconnect the power cord from the wall outlet and wrap it around the cord bracket on the charger like you would a vacuum cleaner. Fig 6



Fig 1



Fig 2



Fig 3



Fig 4



Fig 5



Fig 6

NOTICE

When the PPU-S's battery is running low, it will emit a steady tone when pressing the up or down button on the wired remote. This indicates that it's time to recharge the battery. Each charge is good for at least 10 lifts depending on the weight of the person being lifted. If you need to use the PPU-S when the battery requires charging, or if the battery fails to operate the PPU-S, the lift can be operated with the power cord connected to an AC wall outlet. Fig 3

⚠ WARNING

California requires the following notice: **WARNING: Lithium-ion batteries and products that contain lithium-ion batteries can expose you to chemicals including cobalt lithium nickel oxide, and nickel, which are known to the State of California to cause cancer and birth defects or other reproductive harm.**

Moving the PPU-S

Almost any able-bodied person, as young as 8 years old and under adult supervision, can move the PPU-S around in a single level space. The person moving the PPU-S stands behind the lift and places one foot on the motor at the rear of the unit and then gently tilts the PPU-S rearward by pulling the handles toward them. They can now pull or push the PPU-S to the required location.



PPU-S User's Manual

Raising or lowering the lift height to match the height of the user provides a more comfortable transport. It is more practical in many cases to pull the PPU-S from behind allowing the operator the ability to open doors and traverse thresholds and other impediments to smooth travel.

WARNING As you stop at the desired location, ALWAYS ENSURE THERE ARE NO FOREIGN OBJECTS BENEATH THE SEAT *BEFORE* LOWERING THE SEAT AND BEFORE TILTING THE UNIT BACK TO THE UPRIGHT POSITION IN ITS STORED LOCATION!



General PPU-S Operation:

NOTICE Ensure that any users are thoroughly familiar with the correct operation of the PPU-S *before* they use it to lift themselves or someone else.

These are the basic operational steps for using the PPU-S to lift a person from the floor to allow them to stand up or transfer to or from another seat.

Floor to Seated Height:

The user gets to the PPU-S by scooting or crawling, or a helper/caregiver maneuvers the PPU-S to the location of the person needing assistance. When available, the helper positions the seat directly behind the user to allow the user to mount the lift via scooting on to the beveled seat or tilting on to the seat from the side.

- 1) **If the fallen person can sit up on the floor and scoot backwards:**
 - i. The fallen person scoots backwards onto the PPU-S's mounting ramp seat, using the rise-assist handles for leverage to get fully seated. (See Figure A)
- 2) **If the fallen person is not able to scoot backwards onto the mounting ramp seat:**
 - i. The patient is helped to lie on the floor in a side-lying position with their legs as far forward a possible, to form an "L" shape.
 - ii. The care-provider removes the rise-assist handle that is closest to the patient and places the PPU-S so that the seat platform is facing the patient's lower legs and the rear edge of the seat platform is as close to the patient's buttocks as possible.
 - iii. The care-provider gently assists the patient to tilt-up onto the seat platform while the patient uses their arms to help push themselves up. (See Figure B)
- 3) Once fully seated in the center and to the rear of the PPU-S's seat, the securement belt(s) can be applied for added security (see page 16).
- 4) The person being lifted, or a helper, presses the "Up" button on the wired remote, the motor engages and smoothly raises the seat.
- 5) If the user can stand up from a chair height, the up button is released at chair height level. With the user's feet properly positioned for standing and using the rise-assist handles for leverage, the user stands up as one would from any chair. (as shown in Figure A)
- 6) If the user is transferring to another seated surface such as a wheelchair, the lift is stopped at approximately 2" (5 cm) above the height of the receiving seat. The two inches allow for a gravity assisted transfer.
 - i. Position the chair/wheelchair as close to the PPU-S as possible and engage the wheelchair brakes.
 - ii. Remove both the armrest of the wheelchair that is closest to the user and the rise-assist handle closest to the chair.
 - iii. Proceed with the transfer. The user reaches for the armrest on the opposite side of the destination seat and slides from the PPU-S to the destination seat. (See Figure C)

WARNING BEFORE TRANSFERRING ANYONE FROM THE PPU-S TO A WHEELCHAIR, ALWAYS ENSURE THE BRAKES ON THE WHEELCHAIR ARE FULLY ENGAGED TO AVOID AN ACCIDENT THAT COULD LEAD TO DEATH OR SERIOUS INJURY.

PPU-S User's Manual

Floor to Full Standing:

- 1) Follow steps 1-3 above.
- 2) Once the person being lifted is fully seated in the center and to the rear of the PPU-S's seat, and their hands are resting on the rise-assist handles. The person being lifted, or a helper depresses and holds the "UP" button, as indicated by the arrow on the wired remote.
- 3) The PPU-S seat plate can either be locked in a stationary position or unlocked to allow the seat plate to rotate forward to assist a user to get to a standing position. (See Figure D to view the PPU-S seat in unlocked mode).
- 4) The seat will rise until the "UP" button is released or at the maximum height of 30" from the floor.
- 5) Once the seated person's weight shifts to their feet, they are standing. (See Figure D).

Figure A depicts the unit being self-operated, the user can scoot onto the seat platform by themselves and is able to stand up from a chair height.



Figure A – Self Operated - Floor to Seated to Stand

Figure B depicts a person being assisted onto the PPU-S from a side-lying position.

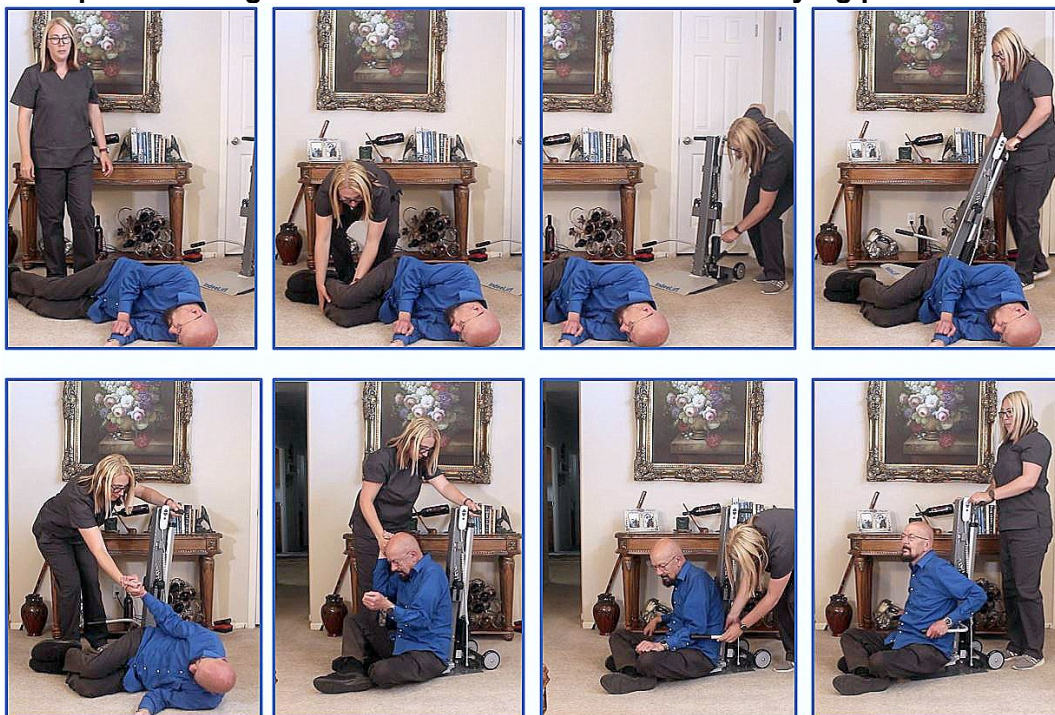

Figure B – Assisted Transfer from Floor onto the PPU-S

PPU-S User's Manual

Figure C depicts a person transferring from the PPU-S to a wheelchair.



Figure C: Transfer from the PPU-S to a Wheelchair

Figure D depicts the PPU-S being self-operated with seat in unlocked mode to allow forward seat rotation.

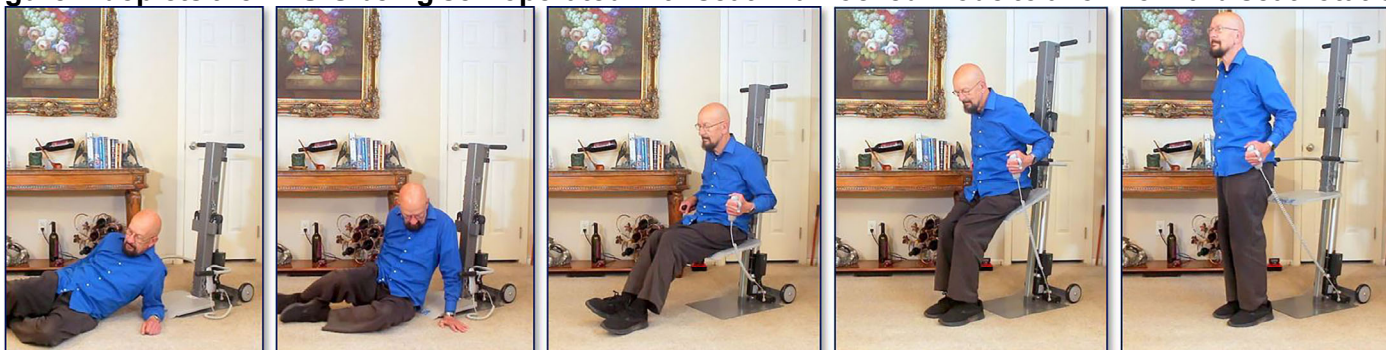

Figure D – Self-Operation Floor to Standing with Seat Tilt

Seated Transfer to PPU-S to Standing

In this scenario, the person needing assistance is seated in a chair, on a bed, on a couch, in a wheelchair or elsewhere. The user will need to be transferred to the PPU-S to assist in raising them to a standing position, (see Figure E, below).

The helper positions the PPU-S directly beside the seated person and uses the wired-remote to position the seat one to two inches below the height of the seated person's buttocks. This positioning facilitates a gravity-assisted transfer eliminating the possibility of injury to the helper/caregiver or the person being lifted.

Either raise the rise assist handle on the appropriate side and swing it rearward or remove it completely by removing the locking pin at the bottom of the handle then lifting the handle upward.

The helper then assists the user to slide to the PPU-S seat. If the assisted person is unable to slide safely, a transfer board may be slid under the user to assist in the transfer.

Once the assisted person is fully seated in the center and to the rear of the PPU-S's seat, have them place their hands on the rise assist handles and let them know you are about to raise the seat. When ready, press and hold the up button, as indicated by the arrow on the wired remote. The seat will rise until the "UP" button is released or at the maximum height of 30" from the floor. Once the seated person's weight shifts to their feet, they are standing.

The Seat-Tilt locks may be disengaged once the patient has been lifted partially off the ground, to ensure the seat rotates with the lifting person. This allows their weight to be rotated directly over their legs as they come to standing.

PPU-S User's Manual

Once a lift is complete, using the wired remote, position the PPU-S seat to the floor or a normal seated height based on the preference of the primary user and return the PPU-S to its storage location.



Figure E – Seated Transfer to the PPU-S

Standing Function

While the primary function of the PPU-S is lifting people from a seated position, the need to lift a standing person a few inches occur regularly for many people. Reaching the tall cabinets in the kitchen or getting up on a tall bed are all activities that are not possible for many people with mobility challenges. In assisted living or skilled nursing environments, a few inches of lift can get a patient onto an exam or x-ray table. The PPU-S provides a safe and reliable method to rise those few inches to reach that space that was out of reach without the PPU-S.

This function is accomplished by **moving the rise-assist handles from the lower mounting brackets to the upper mounting brackets and securing the seat plate in the locked position**. The PPU-S is then placed alongside the cabinet, shelf, closet, or other hard to reach location. With the seat in the fully lowered position, the user stands on the seat and grasps the rise-assist handles. The user, *or a helper*, then presses the up button on the wired remote to raise the seat to the required height but no higher than 14” from the floor as depicted on by the top of the red line located on the caution label. (see Figure E, below).

Once the lift is complete, using the wired remote, position the PPU-S seat to the floor or a normal seated height based on the preference of the primary user and return the PPU-S to its storage location.



Figure E: Floor to Stand – Standing Function

⚠ WARNING ALWAYS PLACE THE MOUNTING RAMP SEAT LOCKS IN THE “LOCKED” POSITION WHEN USING THIS LIFT IN A STANDING FUNCTION AID TO AVOID MISHAPS THAT COULD RESULT IN DEATH OR SERIOUS INJURY.

PPU-S User's Manual

WARNING

NEVER LIFT A STANDING PERSON HIGHER THAN 14 INCHES FROM THE FLOOR DEPICTED BY THE CAUTION LABEL ON THE BACK OF THE UNIT. DO NOT RAISE THE SEAT HIGHER THAN THE TOP OF THE RED LINE WHEN STANDING ON THE UNIT. IT IS UNSAFE FOR STANDING PERSONS TO BE LIFTED ABOVE 14”!



NOTICE

If you remove the rise assist handle, temporarily place the handle in a safe location (where they will not interfere with the transfer).

Securement Belt Information:

The anchor points and belt assemblies are for use when lifting an individual who is non-ambulatory, has minimal upper and lower body strength, or has a condition that causes significant mobility challenges, (e.g., a paraplegic person with no ability to move their legs, a person with cerebral palsy who may need additional help to sit upright on the PPU-S when being lifted, or anyone with neuromuscular conditions that may limit their lower body strength or their ability to stay on the seat unassisted). The belt assemblies can also be used simply as desired for additional safety when lifting an individual.

All procedures that do not involve the use of the waist and chest belt accessories are covered in detail earlier in this Users' Manual and are fully applicable to the PPU-S units.

Using the Belt Assemblies:

Each belt assembly includes two straps; the longer strap has a seatbelt style *buckle* with a snap hook at the end, the shorter strap has a seatbelt style *clasp* with a snap hook at the end. Each of the two straps form a single belt assembly. The two belt assemblies are identical, (*either assembly can be used as a chest belt or a waist belt*).

In use, they are secured to the PPU-S's upper and lower belt anchor points, (located on the PPU-S's main column), using the snap hooks at the end of each belt assembly. The upper belt assembly and anchor points can be used as a chest belt and the lower belt assembly and anchor points can be used as a waist belt.

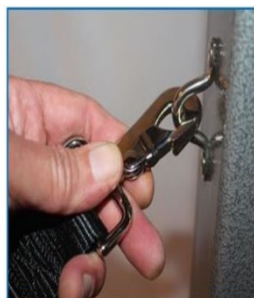
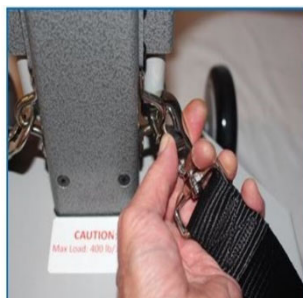
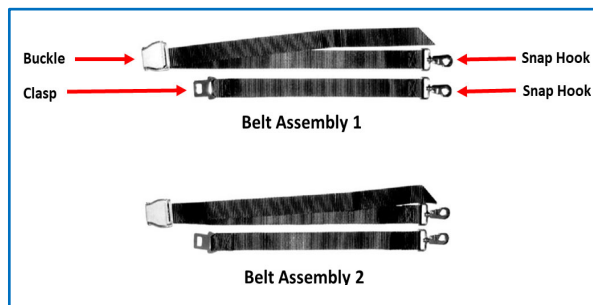

PPU-S User's Manual



NOTICE

Depending on the circumstances, you may choose to use the waist belt only. The anchor points and belt assemblies also allow for additional configurations, (such as crossing the chest of the person being lifted by attaching one belt assembly to the upper left and lower right anchor points and the second belt assembly to the upper right and lower left anchor points).

NOTICE

Once the fallen individual is securely buckled to the lift using the belt assemblies, pull on each buckles' strap to ensure both belts are snug and secure *before* pressing the up button on the wired remote. As the seated person is being lifted, have them gradually move their legs inward, then ensure their feet are properly positioned *before* they stand up from the PPU-S's seat, (as the would from any chair).

NOTICE

When lifting a person with little-to-no lower body strength, (such as a paraplegic), the belts will hold the person securely in place and their legs will naturally move inward towards the PPU-S as they're being lifted. *A person properly secured to the PPU-S using the two belt assemblies cannot fall off the PPU-S's seat!*

Maintenance:

The IndeeLift PPU-S requires no regular maintenance. All exposed surfaces can be cleaned with standard cleaning products. Keeping the battery charged helps improve battery life.

NOTICE

While the PPU-S is extremely durable and will perform well indoors or outdoors, it is recommended that the PPU-S be stored indoors when not in use.

PPU-S User's Manual

Troubleshooting / Service:

The PPU-S was designed to provide years of trouble-free performance. There are no user serviceable parts. However, should you encounter a situation where the unit is not operating properly, please ensure you have correctly followed the procedures for recharging the unit (covered in the **Charging the Battery** section of this manual on Page 9).

If charging the unit does not resolve the problem, or if you encounter any other operational issues with this unit, please contact IndeeLift Customer Care at the number below. Our knowledgeable associates will help to diagnose the problem and present a plan for swift resolution.

IMPORTANT: When contacting IndeeLift Customer Care, please be prepared with your model number, serial number, purchase date and a detailed description of the problem.

**Contact IndeeLift Customer Care
toll-free at 844-700-LIFT (5438)**

Physical Specifications:

Model	PPU-S
Safe Working Load	400 lbs. (180 kg)
Overall Depth	26.5" (67 cm)
Maximum Overall Height (raised).....	70.75" (174 cm)
Minimum Overall Height (lowered).....	41.75" (100 cm)
External Width incl Rise Handles.....	23" (58cm)
Maximum Seat Height	30" (76 cm)
Seat Width.....	14" (35 cm)
Wheel Diameter.....	5" (13 cm)
Unit Weight	78 lbs. (38kg)
Securement Belt System	Standard

Electrical Specifications:

Standard 2-prong 110V AC Power 9' (2.74m) cord (USA)	
Standard 2-prong 220V AC Power 9' (2.74m) cord (Rest of World)	
Operating environment: 41° to 104°F (+5°C to 40°C)	
Battery and System: 24V	
Lithium-Ion Battery Pack.....	Standard
"Smart" Charger.....	Standard

PPU-S User's Manual

Warranty Information:

IndeeLift, Inc. warrants to the original purchaser that this product and the components thereof will be free from defects in workmanship and materials for a period of **one year** from the original date of purchase. IndeeLift, Inc. will, without charge, repair or replace at its option, any defective components or the whole product if necessary. Shipping charges may apply. If a total replacement is necessary, IndeeLift, may upon its discretion provide the latest model, which meets or exceeds the specifications of the product to be replaced.

Exclusions:

This warranty does not apply in the event of misuse or abuse of the product or as a result of unauthorized alterations or repairs. IndeeLift, Inc. reserves the right to make changes in design or make additions or improvements to this product without any obligation to install the same on products previously manufactured.

IndeeLift, Inc. shall not be liable for any consequential damages including, without limitations, damages resulting from loss of use. Some states do not allow limitations of incidental or consequential damages, so the above limitation or exclusion may not apply to you. The warranty gives you specific rights and you may have other rights, which vary from state to state.

Owner's Notes:

Model: PPU-S

Serial Number:

Date Purchased:

PPU-S User Manual



For more sales and technical information refer to:

<https://IndeeLift.com>

or scan the bar code:



Refer to videos about the entire IndeeLift family of products on our website

